

BIM & CAD solutions for the AEC Industry

For : Architects Engineers Contractors Surveyors Owners

✉ info@qualitasae.com 📞 US : 516 360 2509 📞 India : +91 9051353736

Architecture : Work Samples

Building Information Model

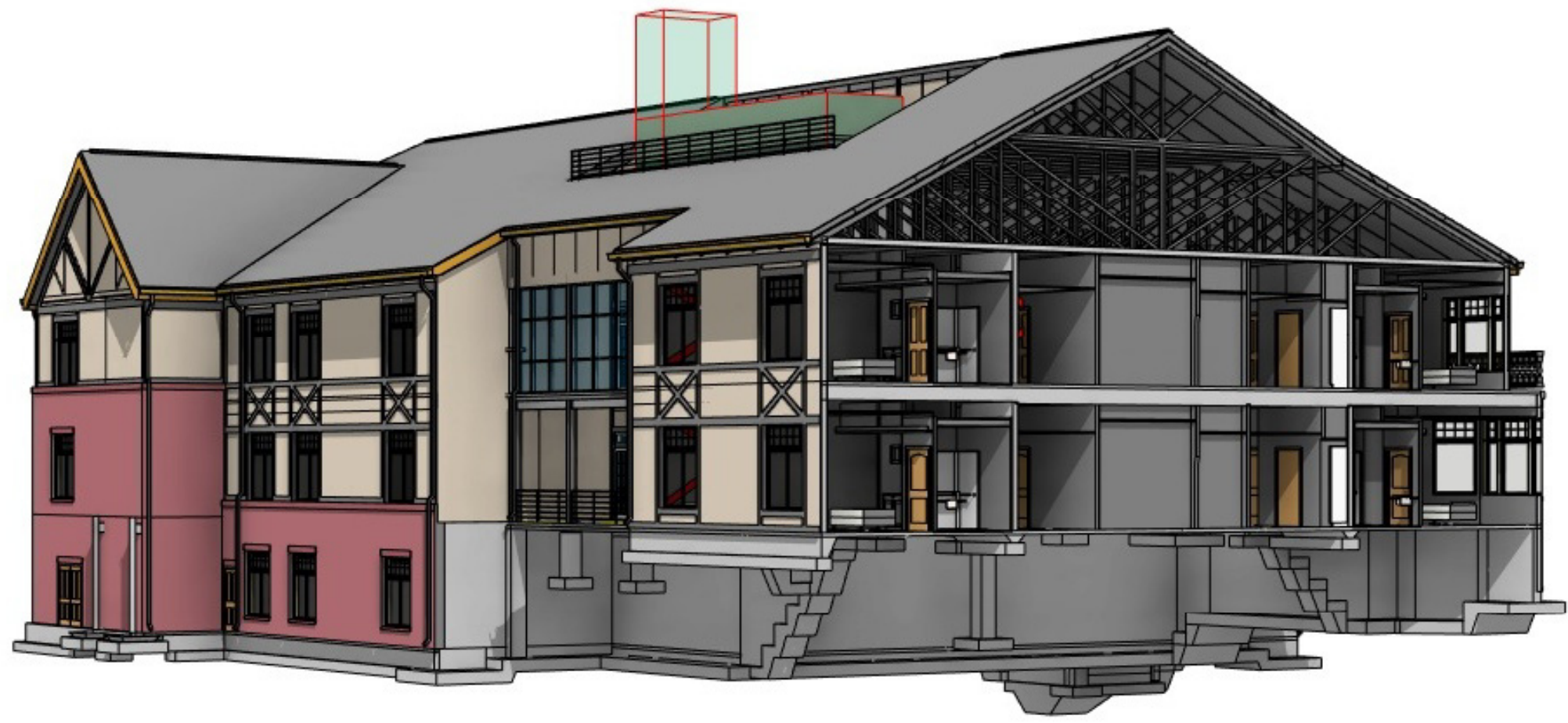

BIM & CAD solutions for the AEC Industry

For : Architects Engineers Contractors Surveyors Owners

✉ info@qualitasae.com 📞 US : 516 360 2509 📞 India : +91 9051353736

Architecture : Work Samples

Building Information Model

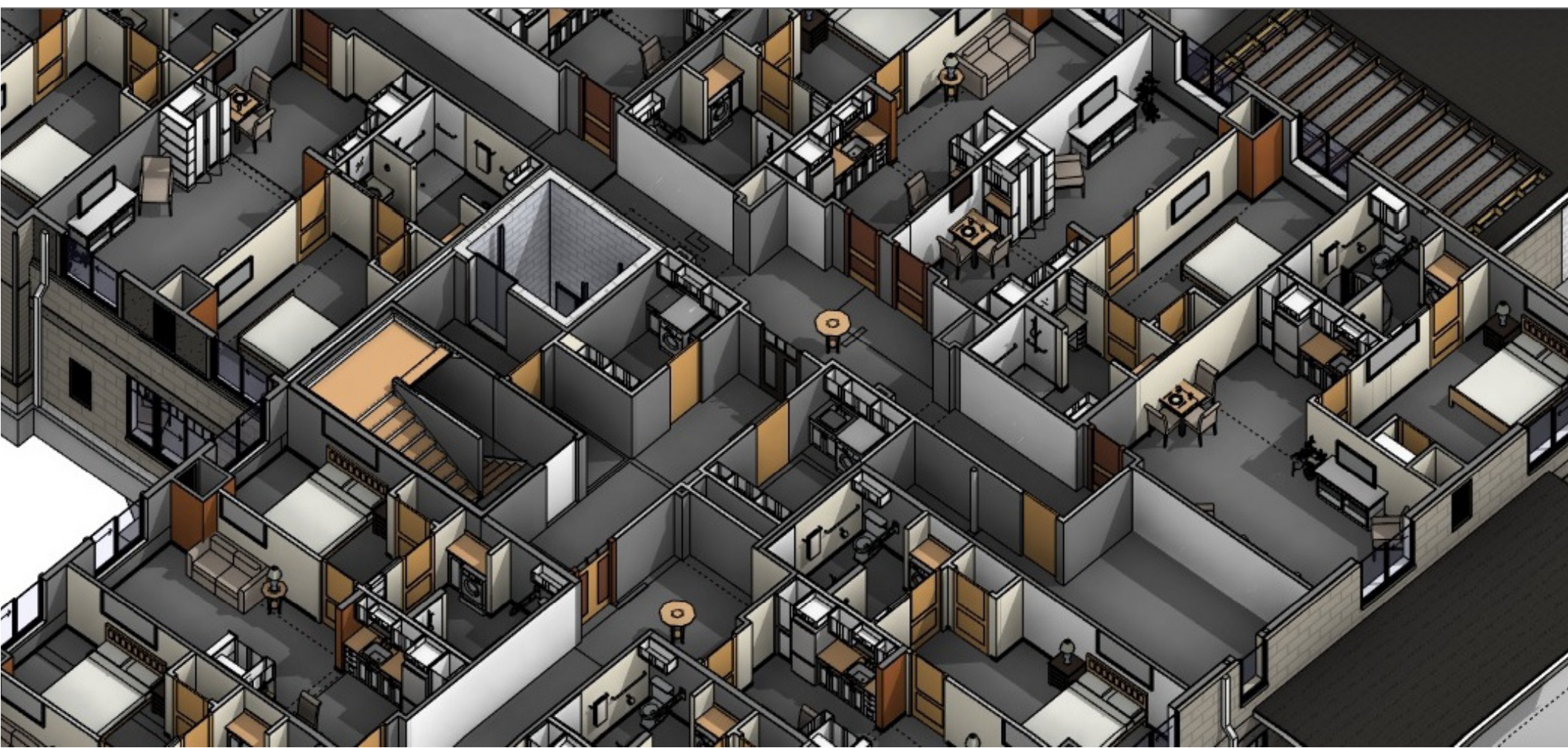

BIM & CAD solutions for the AEC Industry

For : Architects Engineers Contractors Surveyors Owners

✉ info@qualitasae.com 📞 US : 516 360 2509 📞 India : +91 9051353736

Architecture : Work Samples

Building Information Model



BIM & CAD solutions for the AEC Industry

For : Architects Engineers Contractors Surveyors Owners

✉ info@qualitasae.com

📞 US : 516 360 2509

📞 India : +91 9051353736

Architecture : Work Samples

Building Information Model



BIM & CAD solutions for the AEC Industry

For : Architects Engineers Contractors Surveyors Owners

✉ info@qualitasae.com 📞 US : 516 360 2509 📍 India : +91 9051353736

Architecture : Work Samples

Construction Document

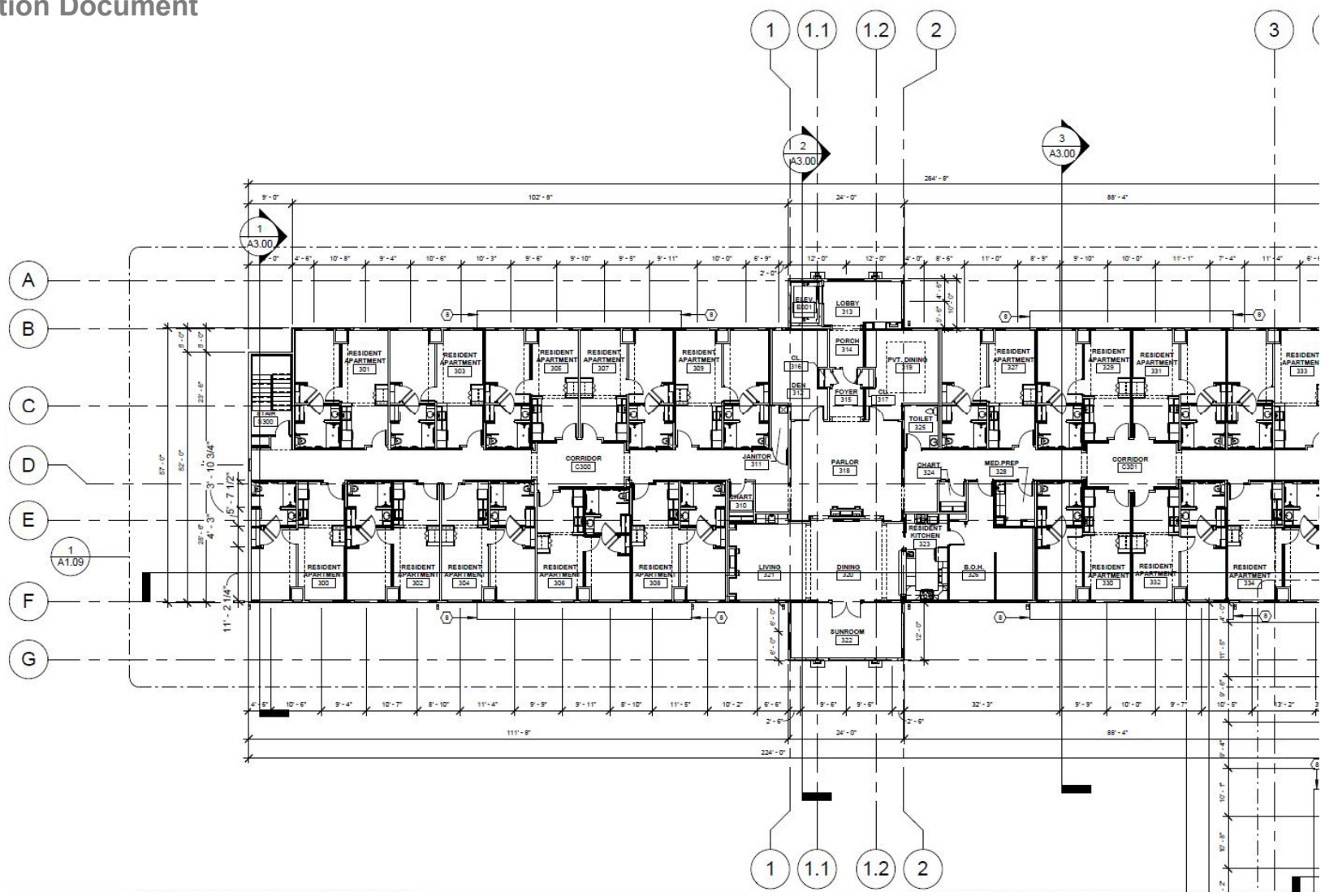

BIM & CAD solutions for the AEC Industry

For : Architects Engineers Contractors Surveyors Owners

✉ info@qualitasae.com 📞 US : 516 360 2509 📞 India : +91 9051353736

Architecture : Work Samples

Construction Document

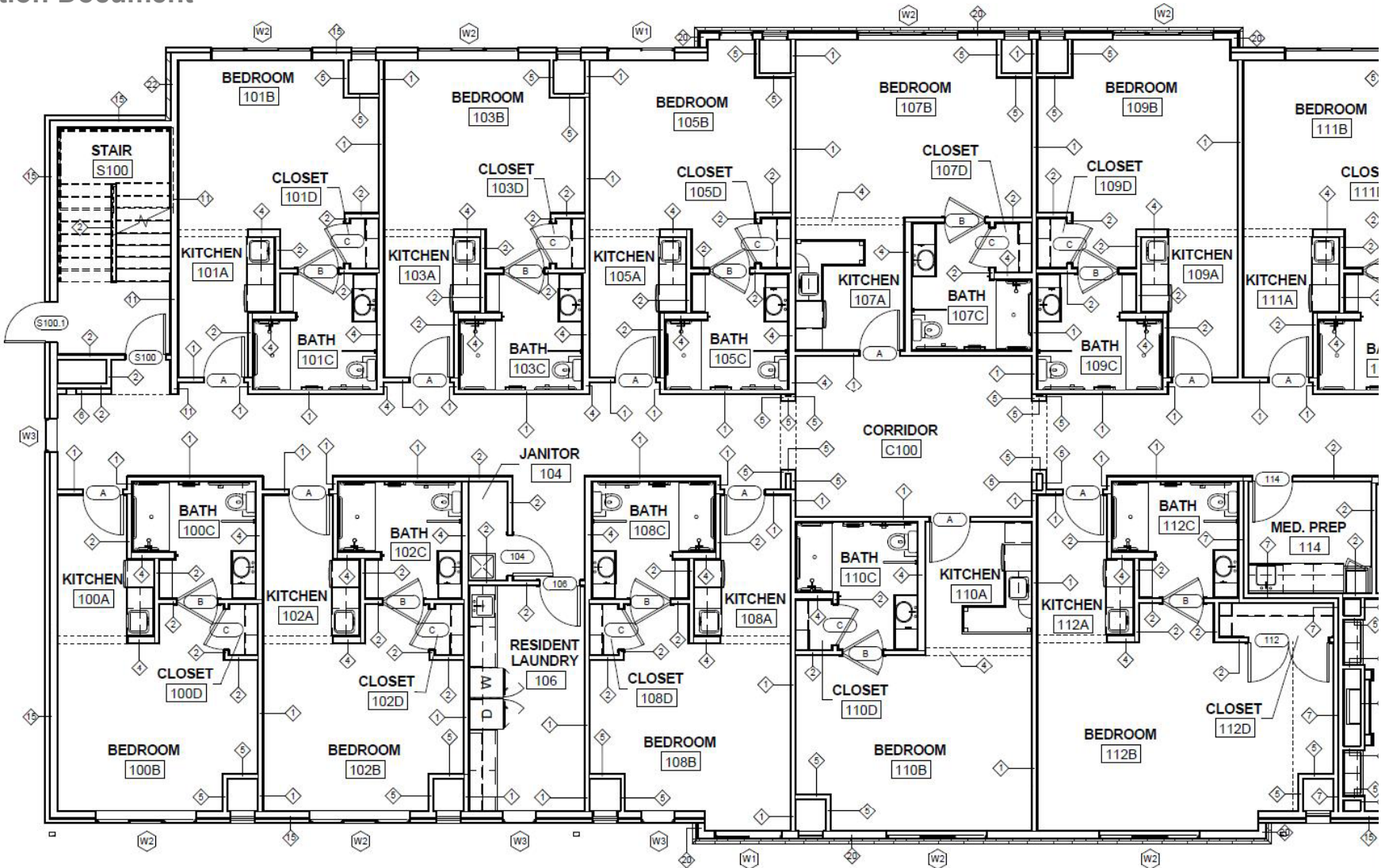

BIM & CAD solutions for the AEC Industry

For : Architects Engineers Contractors Surveyors Owners

✉ info@qualitasae.com 📞 US : 516 360 2509 📞 India : +91 9051353736

Architecture : Work Samples

Construction Document

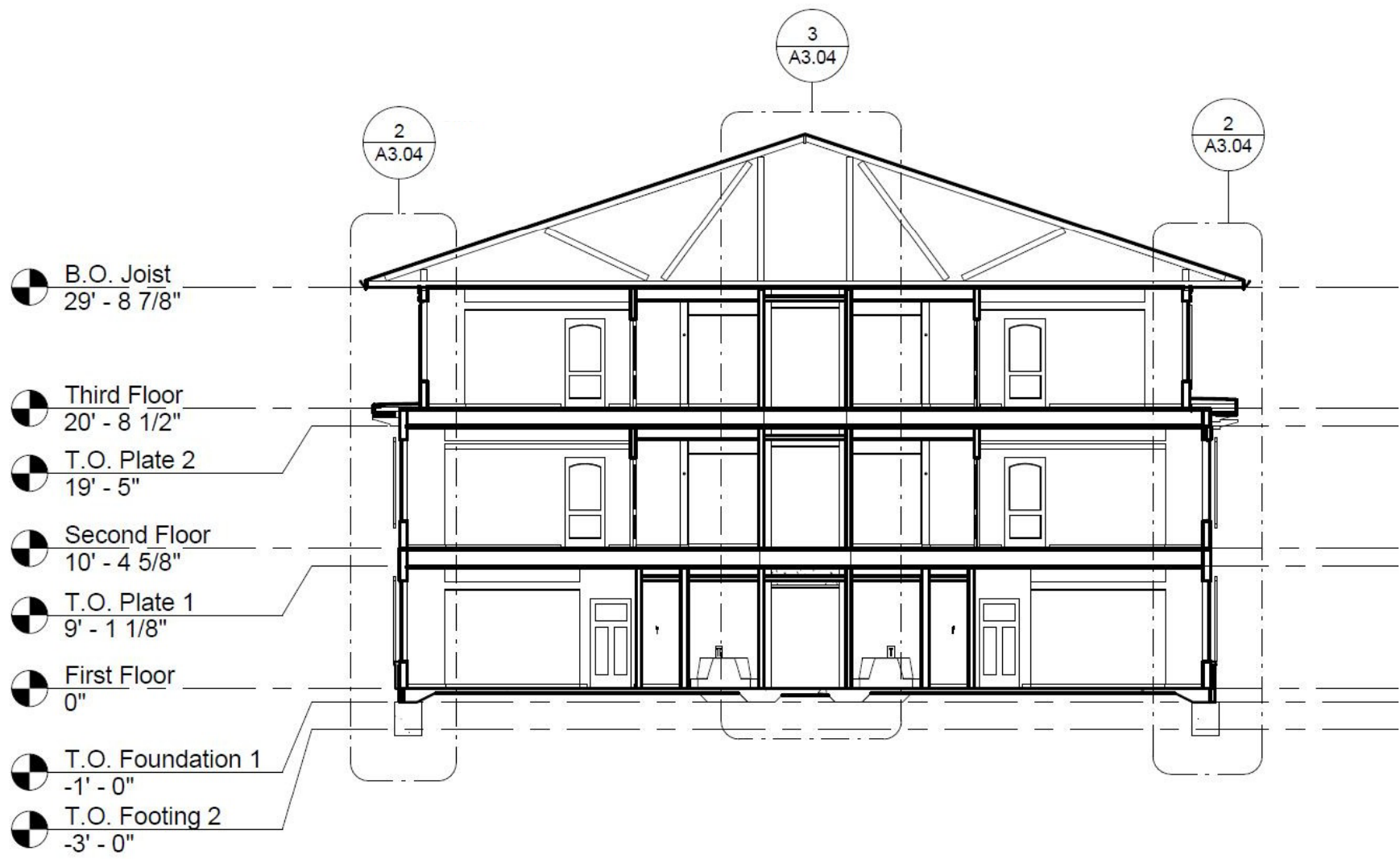

BIM & CAD solutions for the AEC Industry

For : Architects Engineers Contractors Surveyors Owners

✉ info@qualitasae.com 📞 US : 516 360 2509 📞 India : +91 9051353736

Architecture : Work Samples

Construction Document

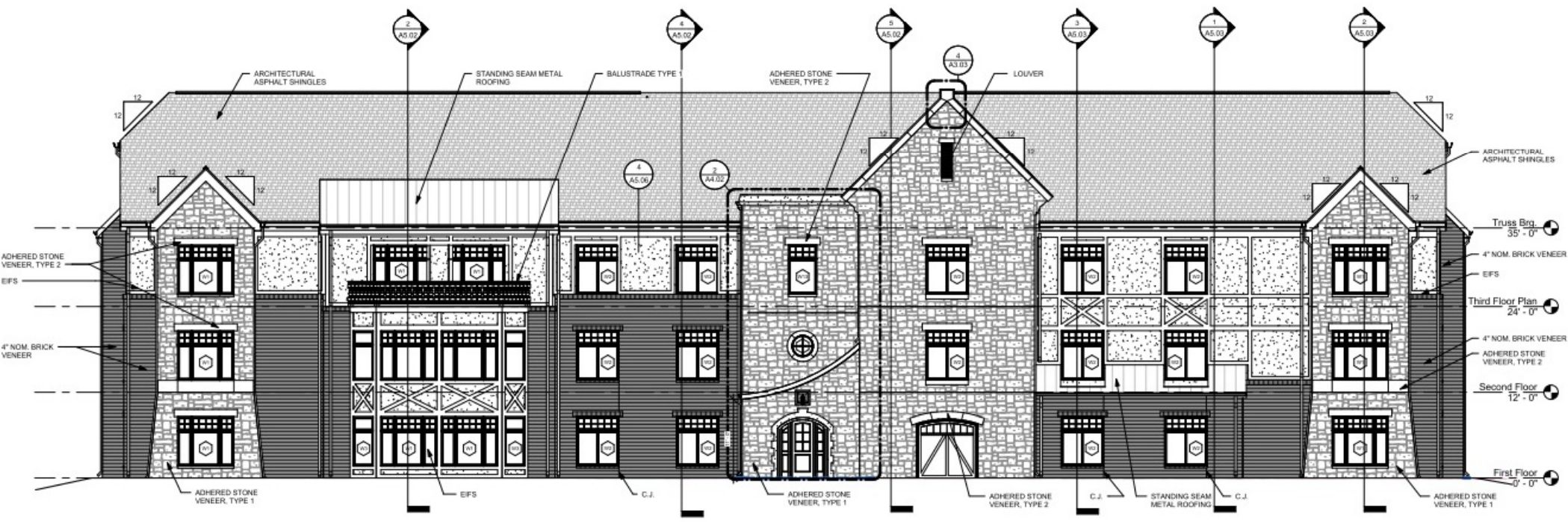

BIM & CAD solutions for the AEC Industry

For : Architects Engineers Contractors Surveyors Owners

✉ info@qualitasae.com 📞 US : 516 360 2509 📠 India : +91 9051353736

Architecture : Work Samples

Construction Document

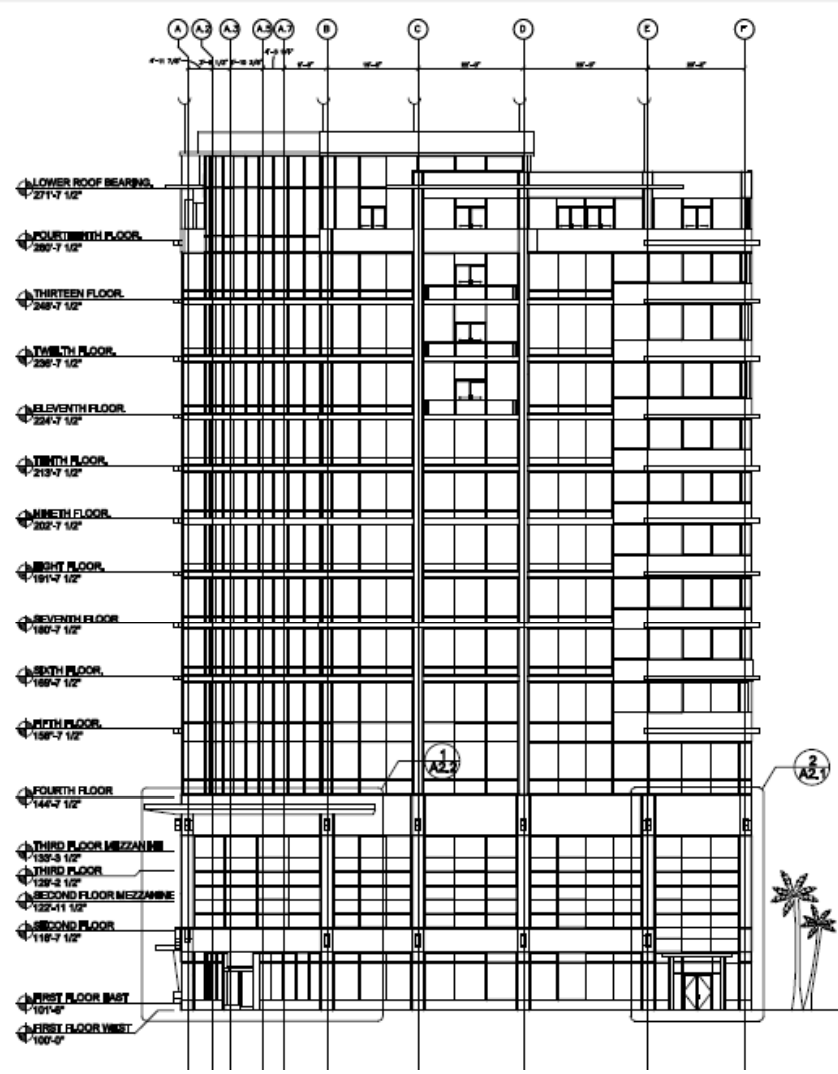
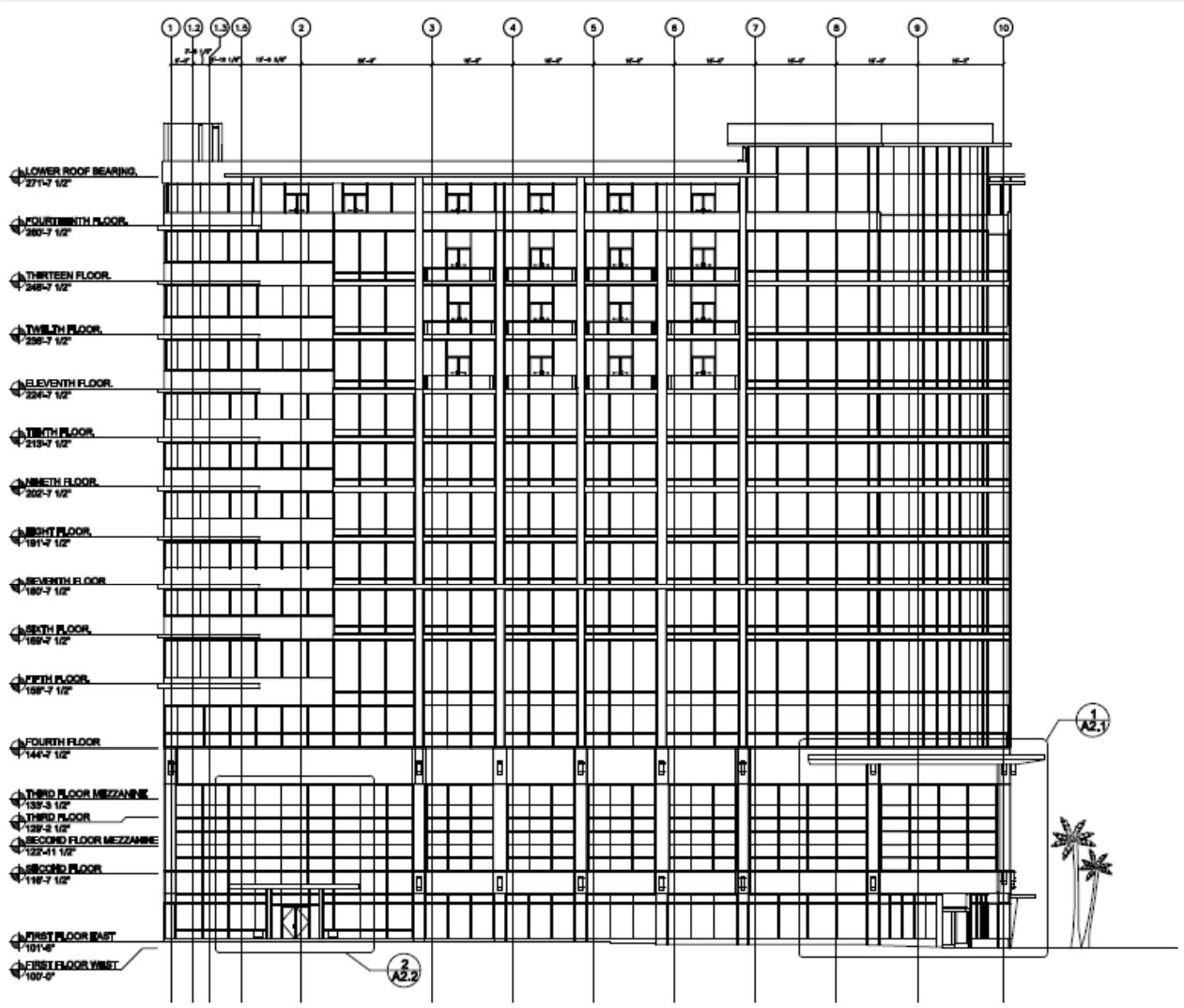

BIM & CAD solutions for the AEC Industry

For : Architects Engineers Contractors Surveyors Developers

✉ info@qualitasae.com 📞 US : 516 360 2509 📞 India : +91 9830273385

Architecture : Work Samples

Construction Document

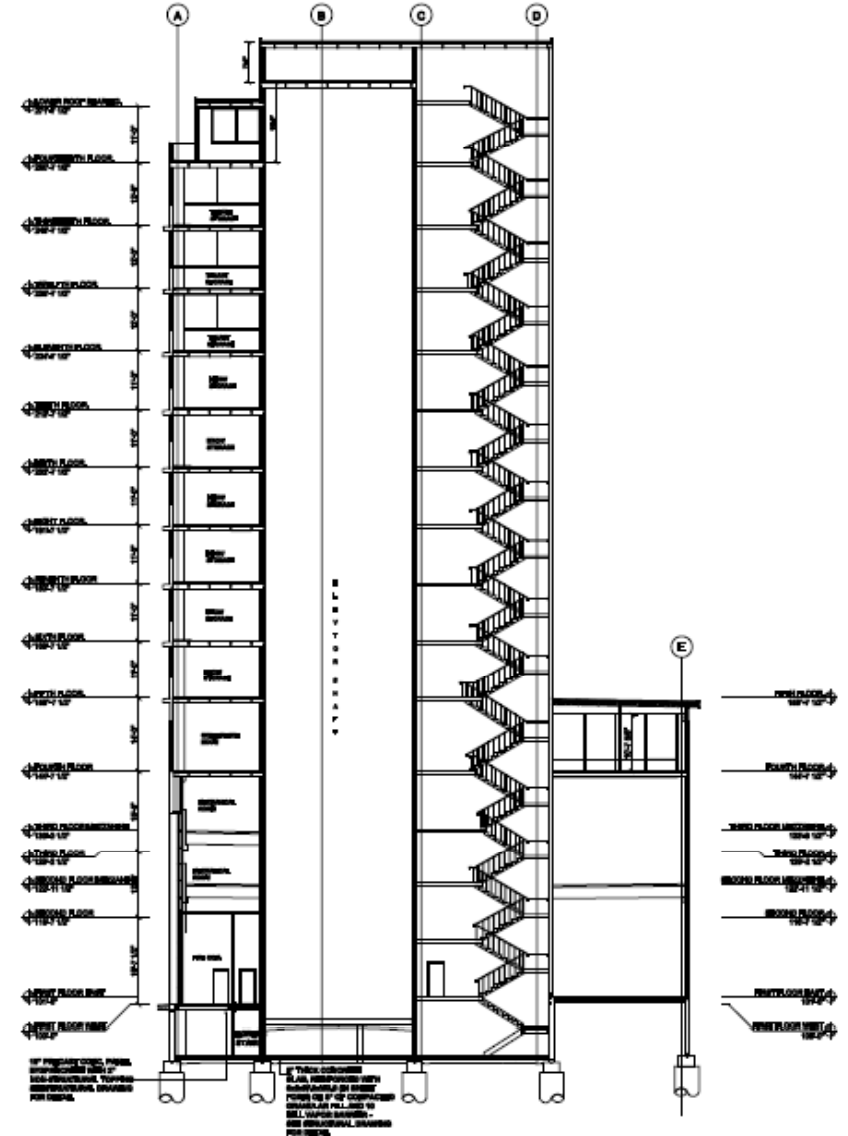
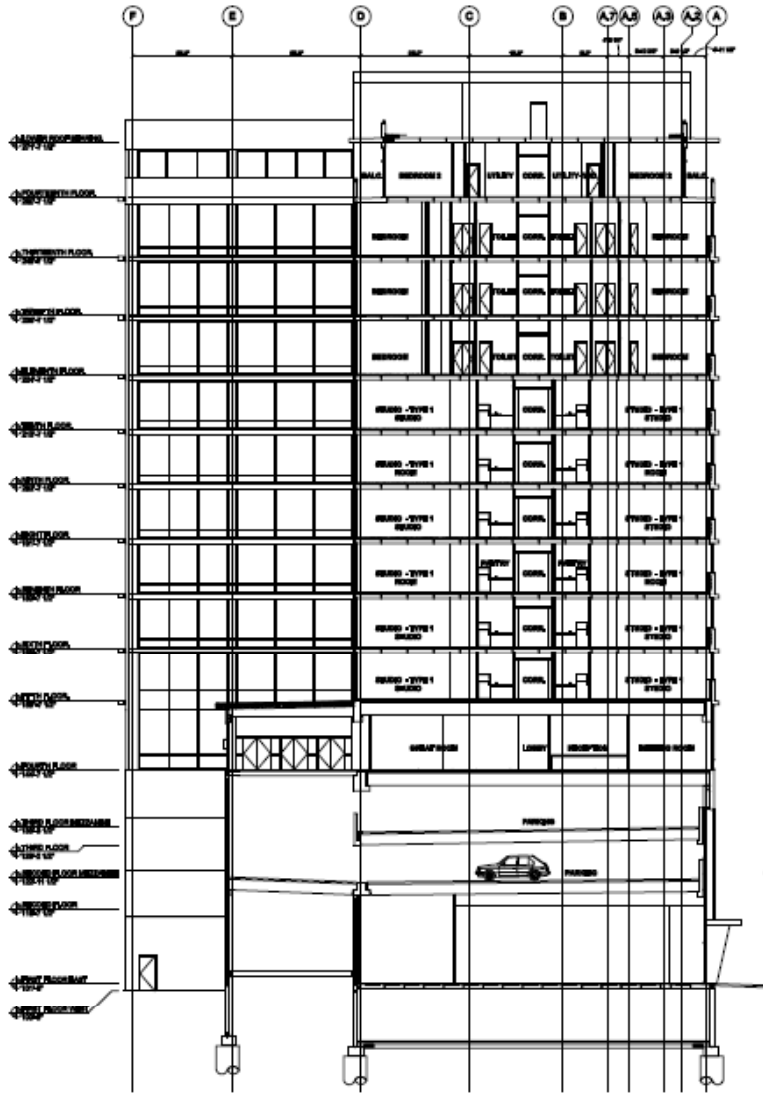

BIM & CAD solutions for the AEC Industry

For : Architects Engineers Contractors Surveyors Owners

✉ info@qualitasae.com 📞 US : 516 360 2509 📠 India : +91 9051353736

Architecture : Work Samples

Construction Document

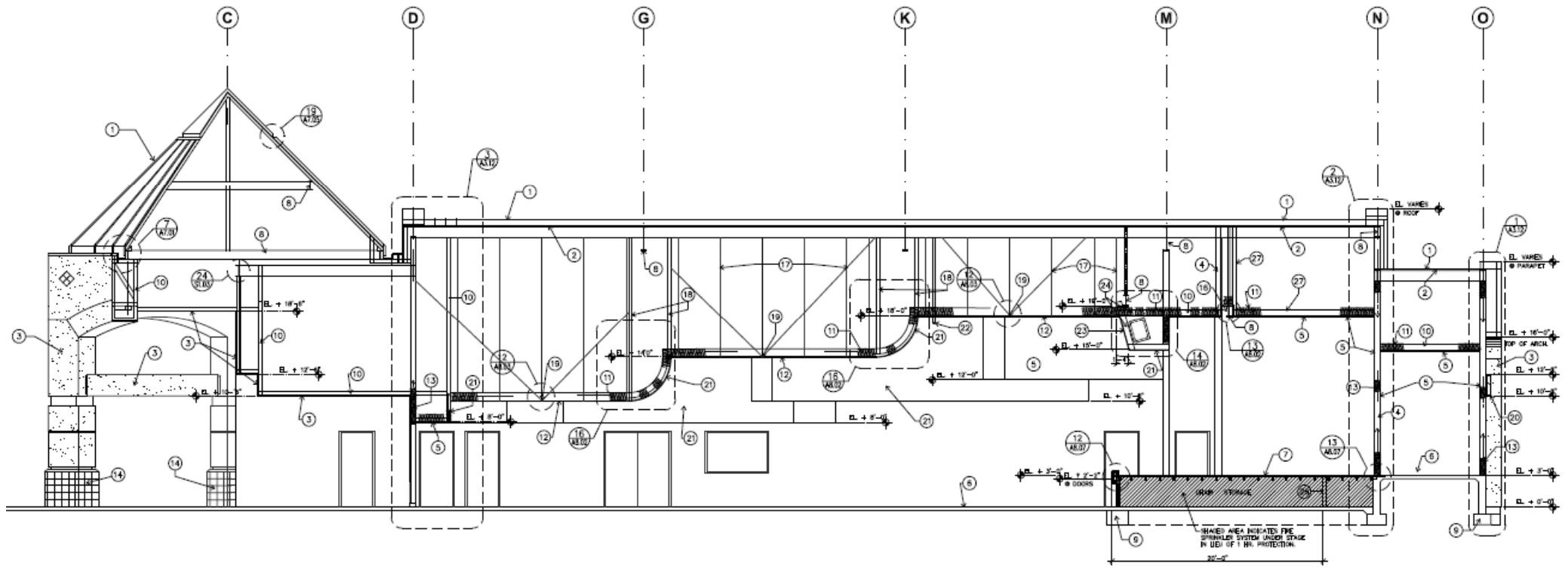

BIM & CAD solutions for the AEC Industry

For : Architects Engineers Contractors Surveyors Owners

✉ info@qualitasae.com 📞 US : 516 360 2509 📠 India : +91 9051353736

Architecture : Work Samples

Construction Document

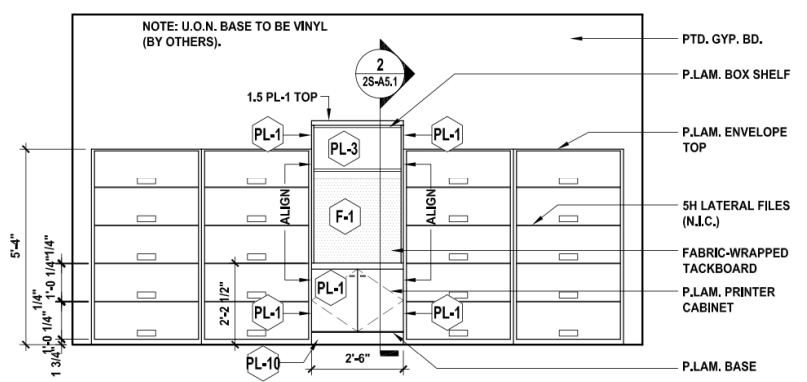
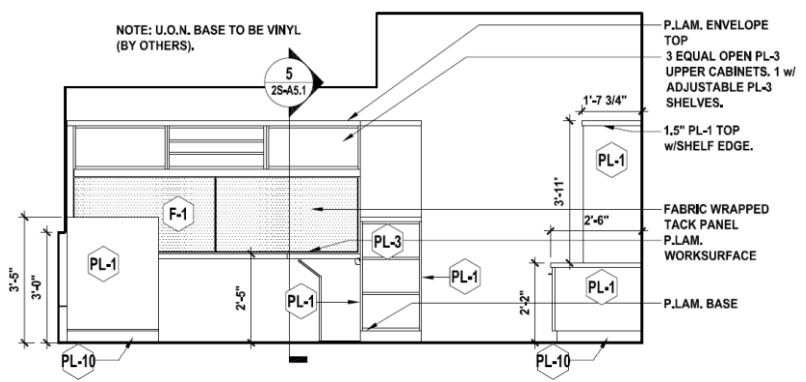
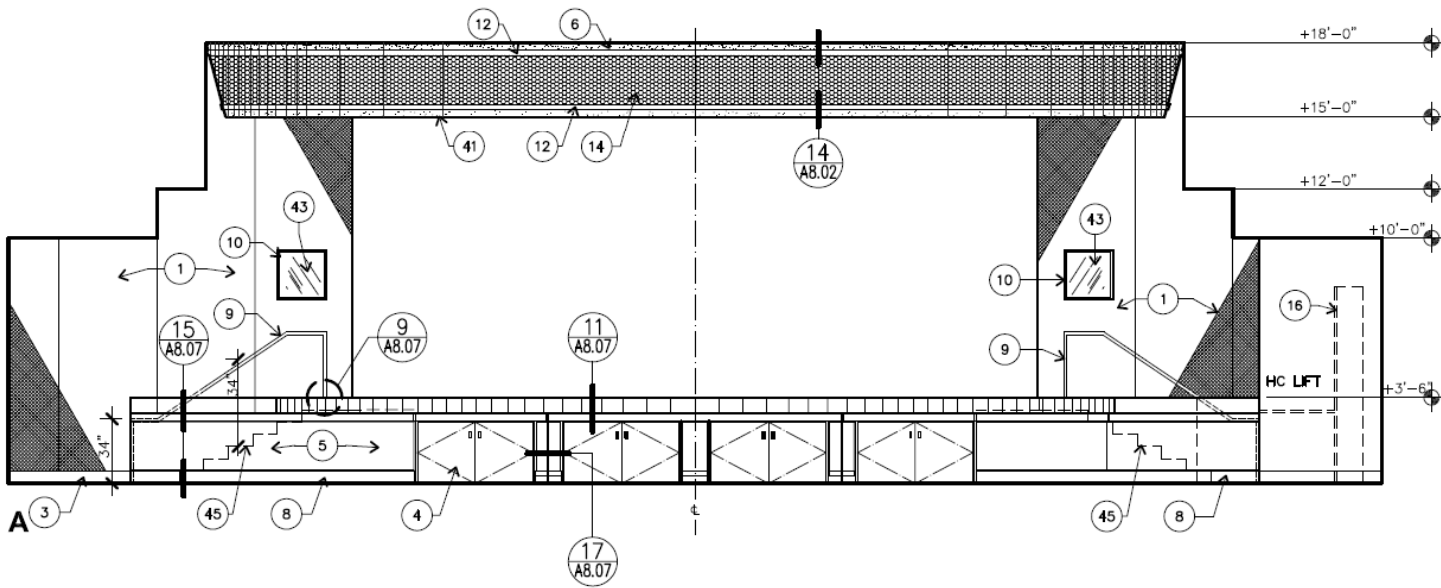

BIM & CAD solutions for the AEC Industry

For : Architects Engineers Contractors Surveyors Owners

✉ info@qualitasae.com 📞 US : 516 360 2509 📞 India : +91 9051353736

Architecture : Work Samples

Construction Document

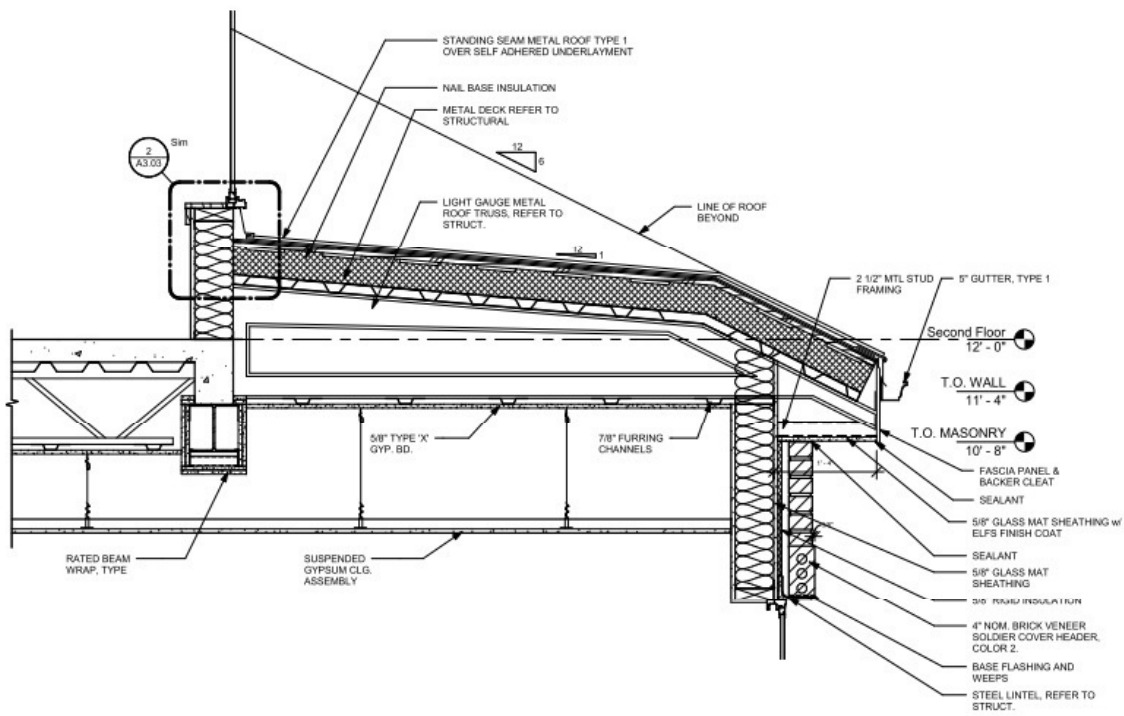
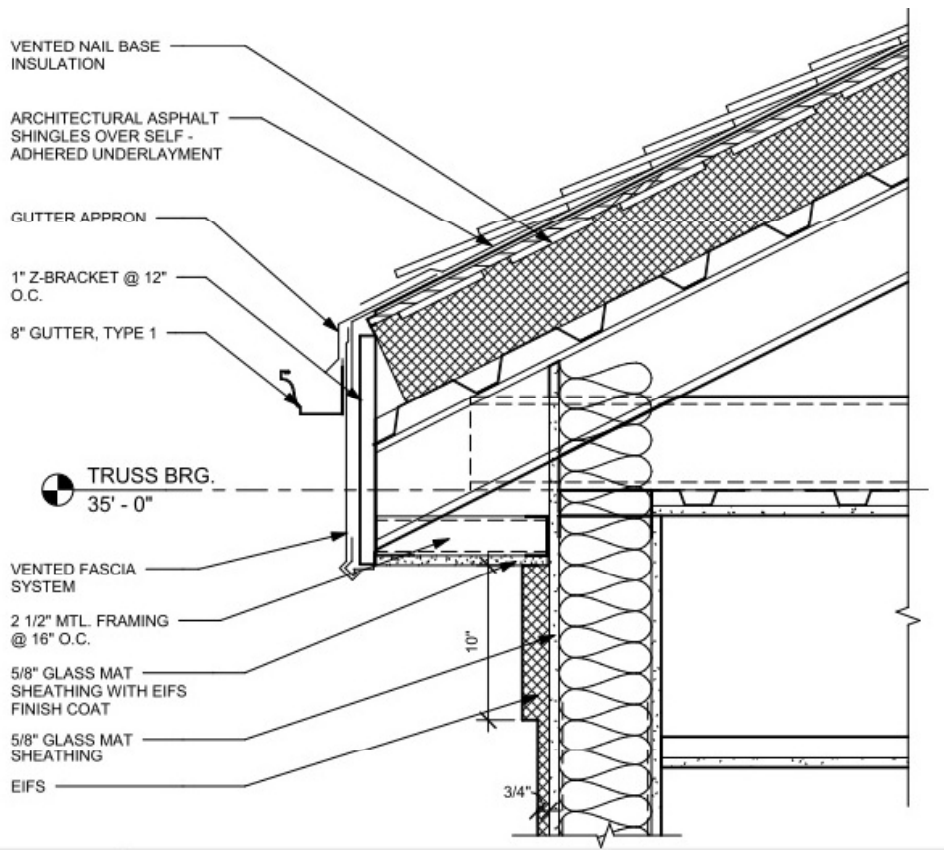

BIM & CAD solutions for the AEC Industry

For : Architects Engineers Contractors Surveyors Owners

✉ info@qualitasae.com 📞 US : 516 360 2509 📞 India : +91 9051353736

Architecture : Work Samples

Redline Pick-ups

Input Output

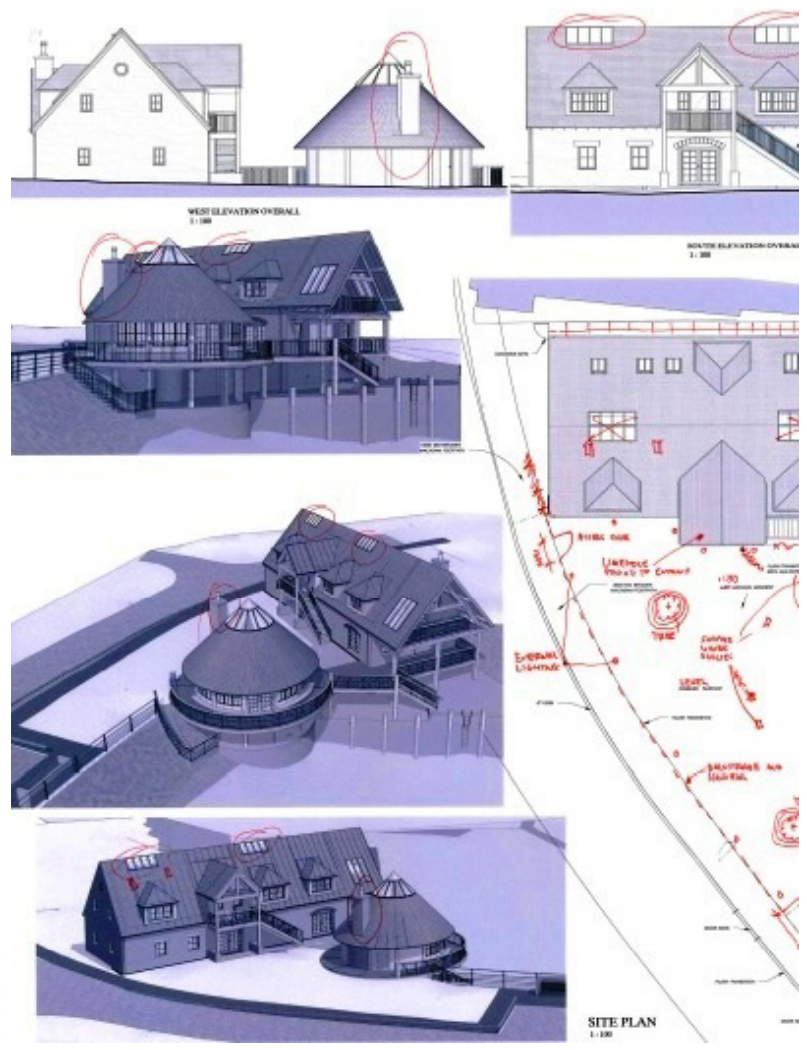

BIM & CAD solutions for the AEC Industry

For : Architects Engineers Contractors Surveyors Owners

info@qualitasae.com US : 516 360 2509 India : +91 9051353736

Architecture : Work Samples

Redline Pick-ups

Input

Output

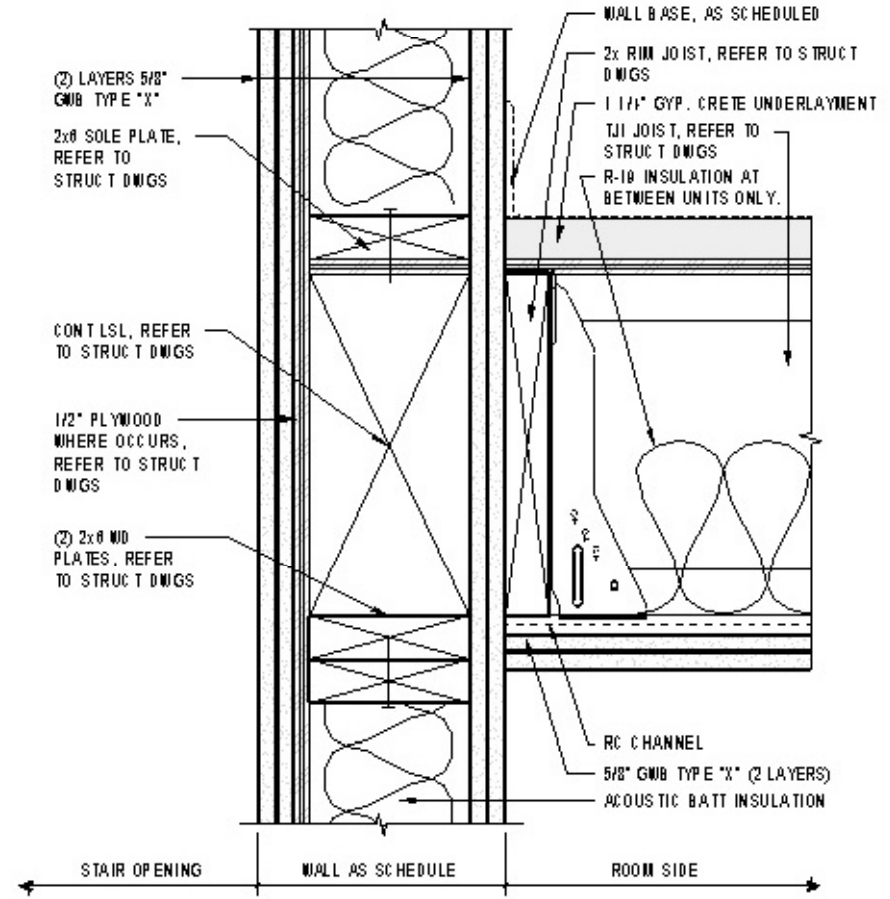
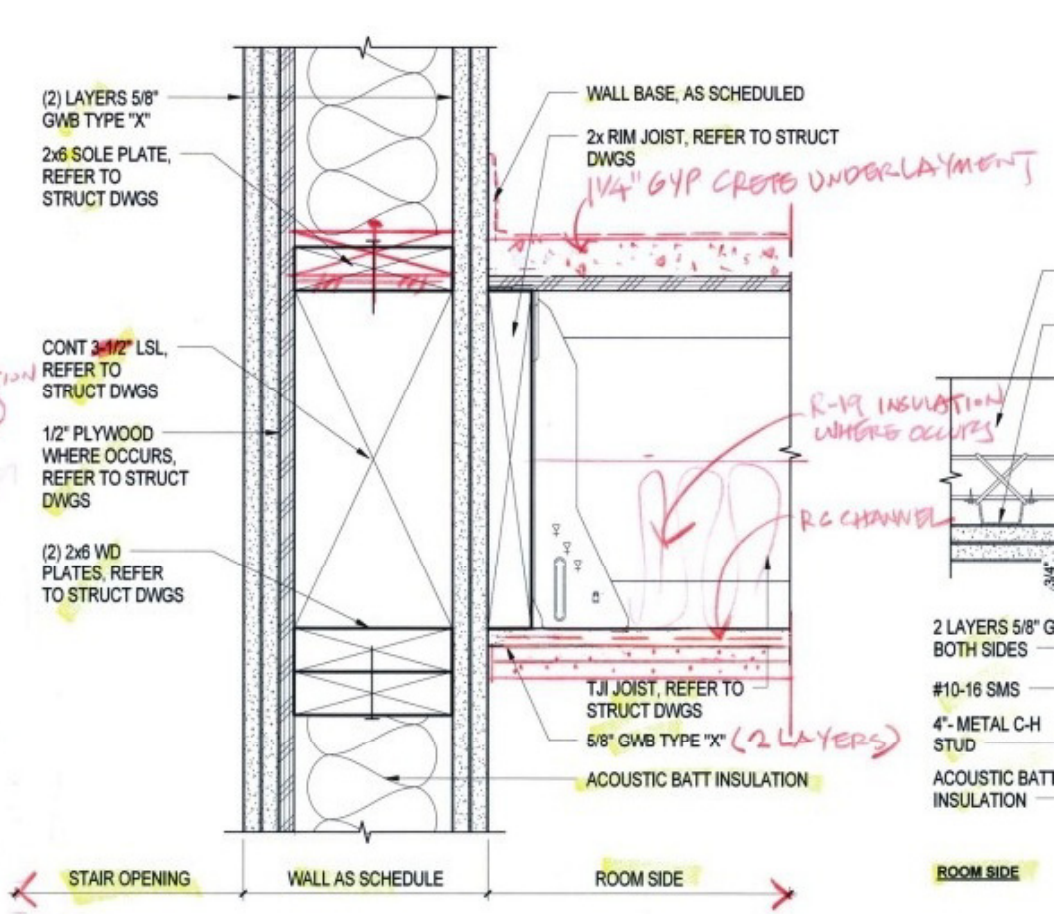

BIM & CAD solutions for the AEC Industry

For : Architects Engineers Contractors Surveyors Owners

info@qualitasae.com US : 516 360 2509 India : +91 9051353736

Architecture : Work Samples

Drawings prepared from Sketches

Input

Output

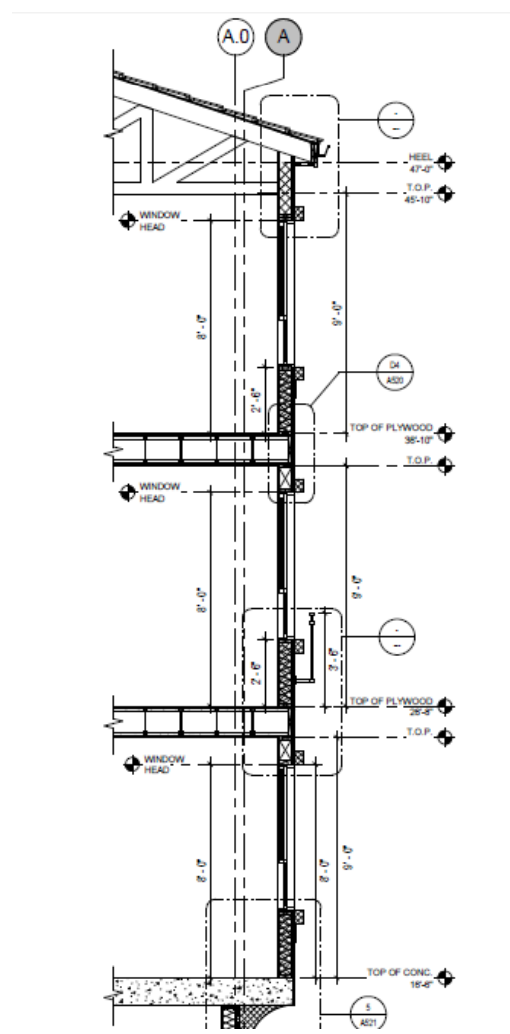
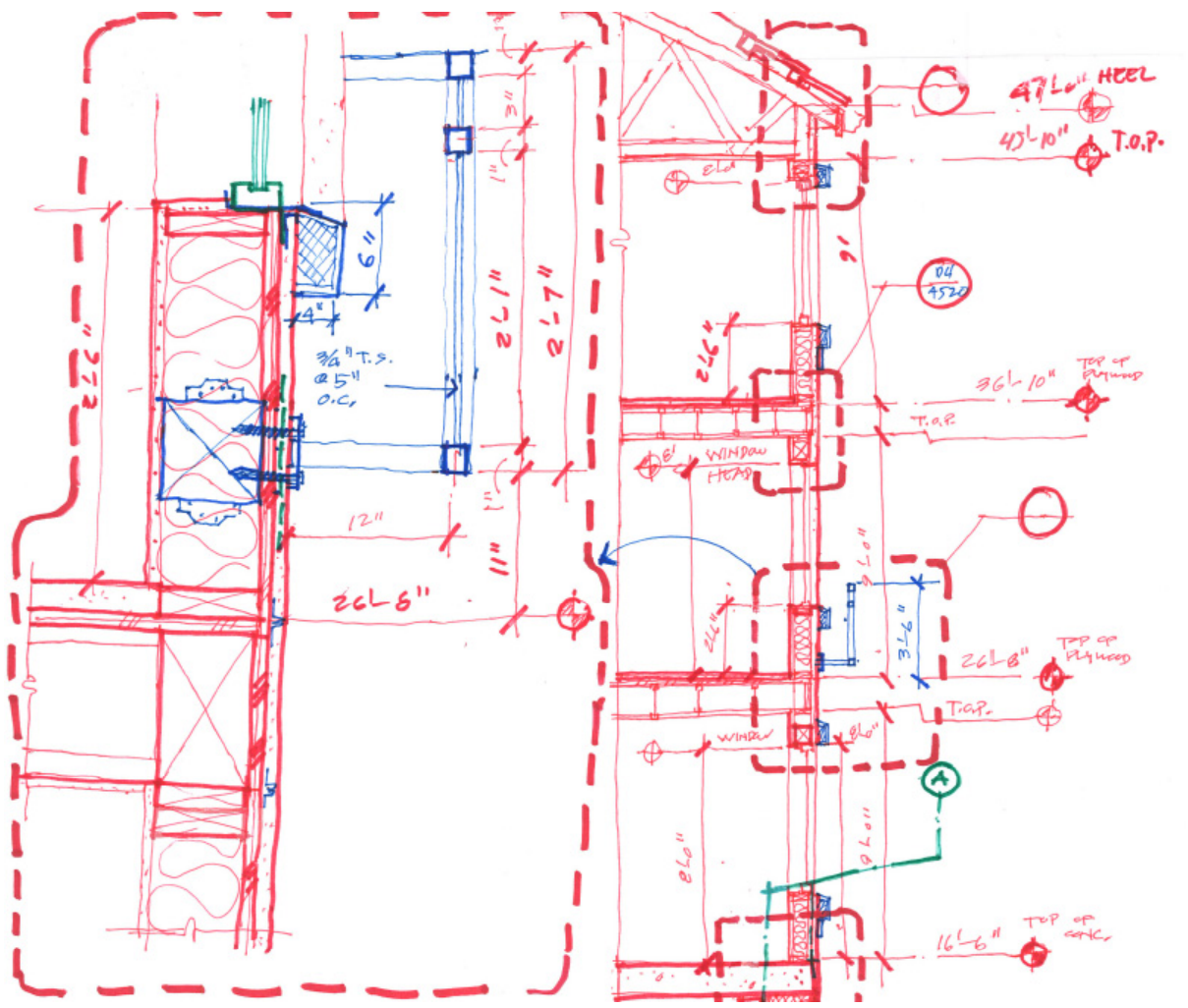

BIM & CAD solutions for the AEC Industry

For : Architects Engineers Contractors Surveyors Owners

info@qualitasae.com US : 516 360 2509 India : +91 9051353736

Architecture : Work Samples

CAD Conversion

Input

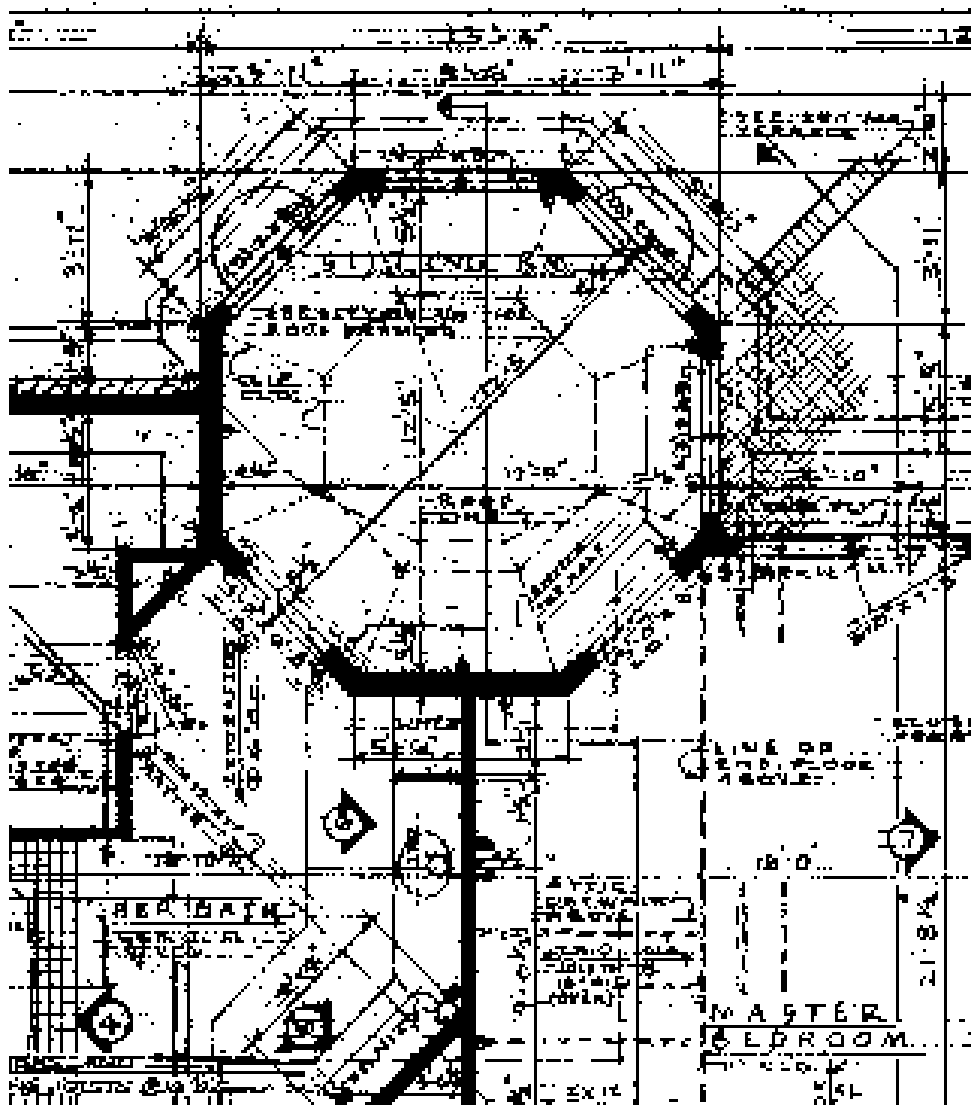

Output

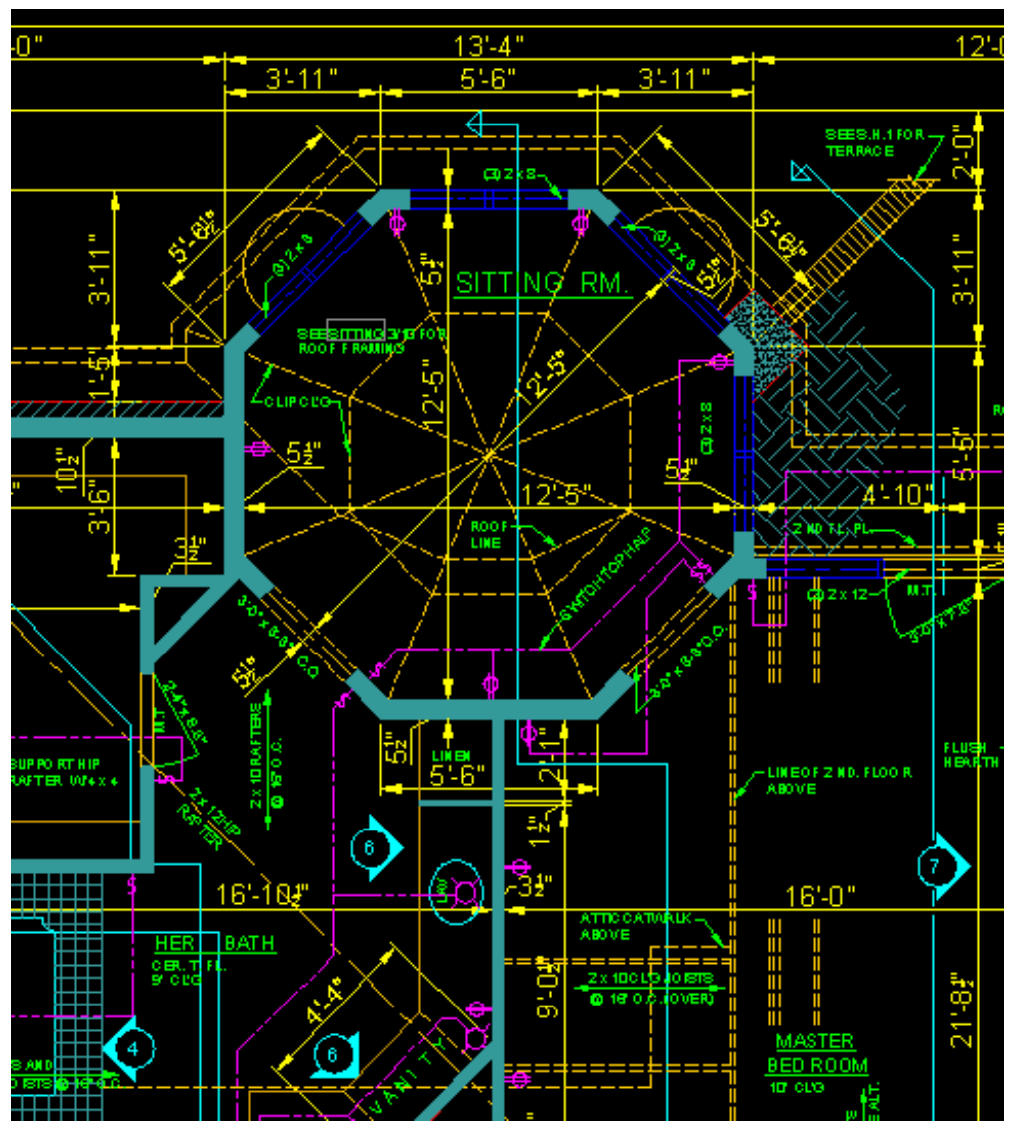

BIM & CAD solutions for the AEC Industry

For : Architects Engineers Contractors Surveyors Owners

✉ info@qualitasae.com 📞 US : 516 360 2509 📞 India : +91 9051353736

Architecture : Work Samples

CAD Conversion

Input



Output

